

User manual for RS IdeaWerk Pro 3D printer



Created/edited by	Version	Date
Diana Thomas-McEwen	V2	17/05/2016
Diana Thomas-McEwen	V3	30/08/2016

Table of Contents

1.0	Machine Familiarisation.....	2
1.1	Basic machine exterior set up.....	2
1.2	How do they work?.....	3
2.0	Materials.....	3
2.1	PLA.....	4
2.2	ABS.....	4
2.3	Other material available.....	4
3.0	Where can I get the design?.....	5
3.1	Obtaining an STL File.....	5
3.2	Designing a file.....	6
3.3	Checking the STL file for errors.....	7
3.4	Processing the STL file using DoraWare-P.....	10
	Fill density.....	12
	Layer Height and Print speed.....	12
	Shell.....	12
	Raft.....	12
	Exterior Supports.....	13
	Height(mm).....	13
	Extruder temperature (°C).....	13
	Platform temperature (°C).....	13
3.4.1	Generating the GCode.....	14
3.4.2	Producing the WTK file from DoraWare-P.....	17
4.0	Setting up the RS IdeaWerk Pro 3D printer.....	18
4.1	Setting up the printer.....	18
4.2	Starting to print.....	19
4.3	Finished printing.....	20
5.0	Charge forms.....	21
5.1	How does it work?.....	21
6.0	Health and Safety.....	22
6.1	What could go wrong.....	22
	Appendix A -Trouble shooting.....	24
	NOTES.....	24

RS IdeaWerk Pro 3D printer User Manual

1.0 Machine Familiarisation

1.1 Basic machine exterior set up

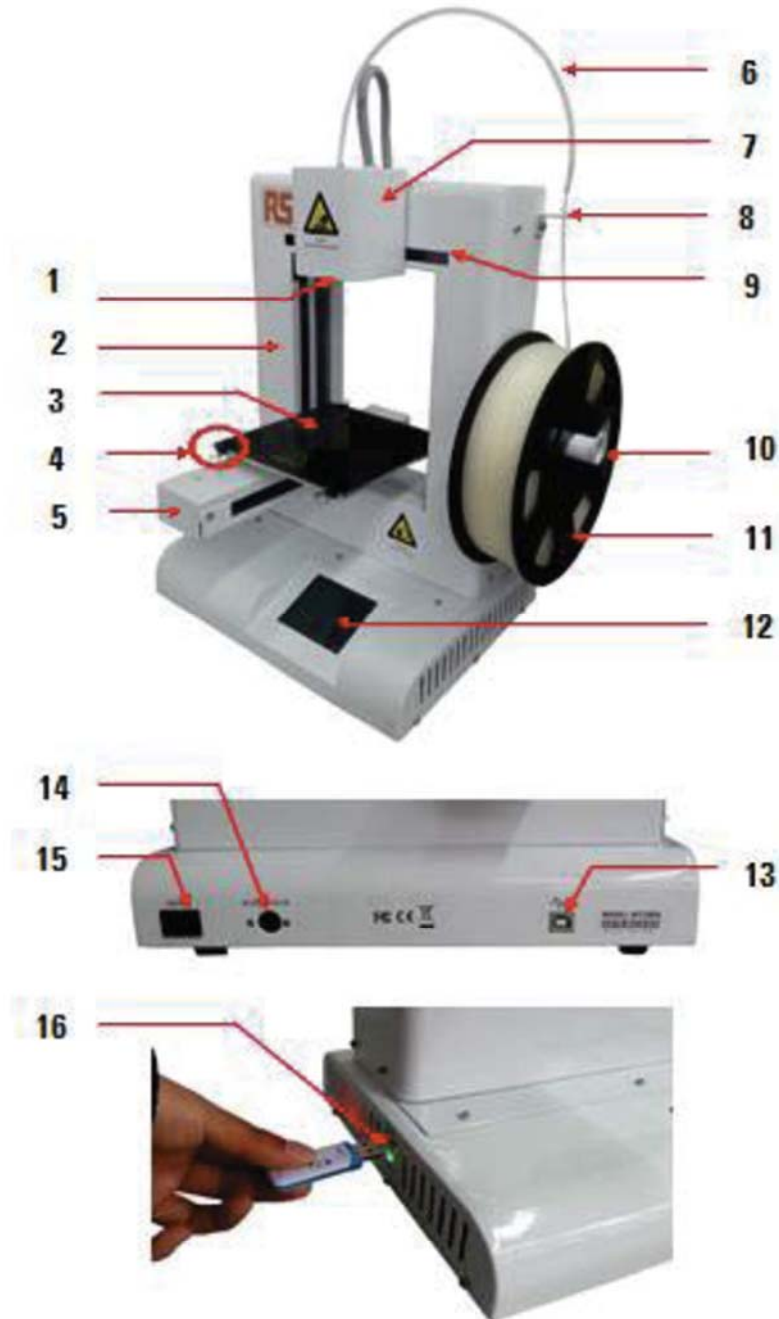

1. Nozzle
5. Y-Axis
9. X-Axis
13. USB Interface

2. Z-Axis
6. Teflon Tube
10. Spool Holder
14. Power Input

3. Building Plate
7. Extruder
11. Filament Spool
15. Power Switch

4. Clips
8. Filament Guide
12. Touch Screen
16. USB Slot

1.2 How do they work?

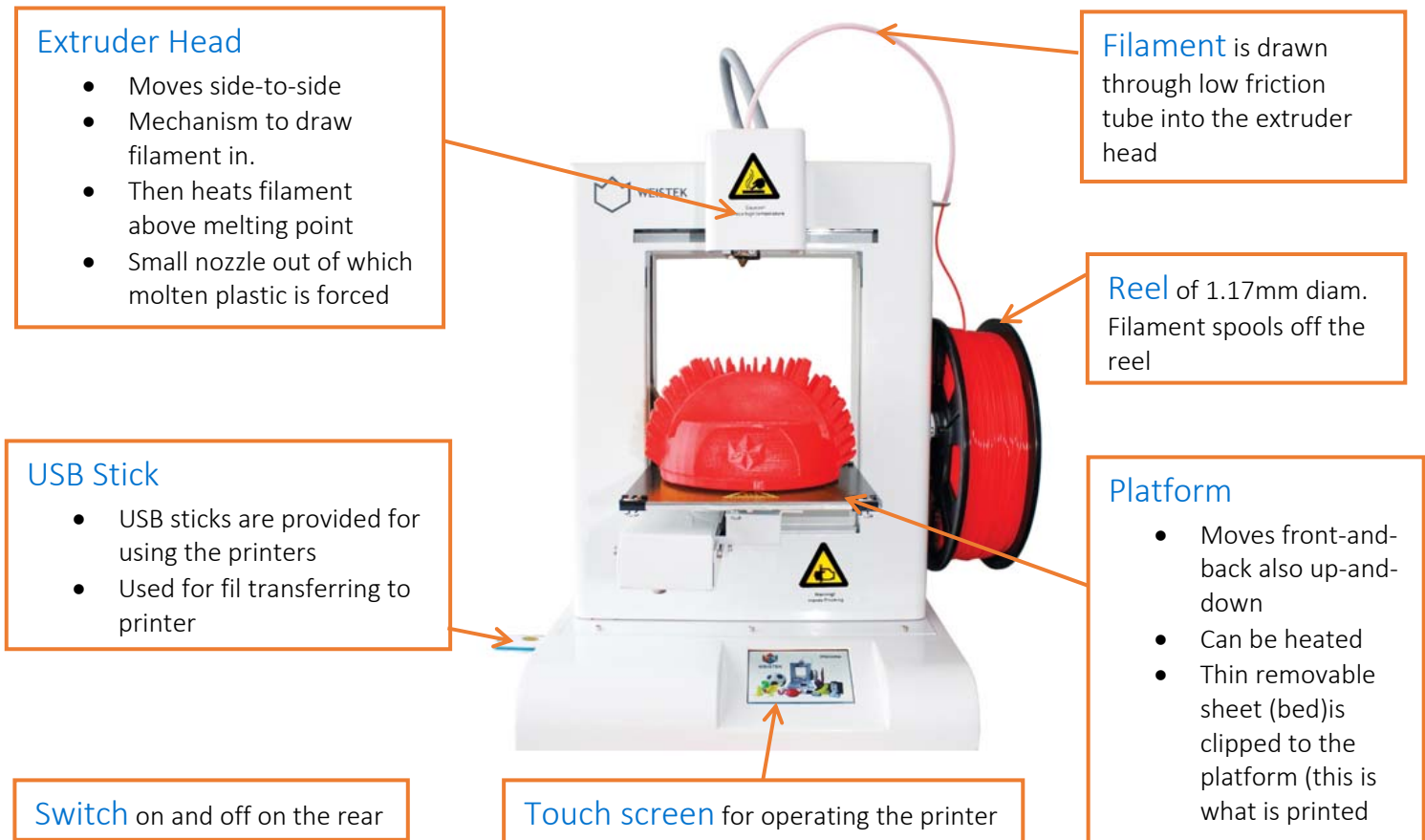

The extruder can have temperature set to anywhere between 190°C and 280°C and the platform can have temperature set to anywhere between room temperature and 100°C. The ability to set both temperatures governs the ability to print different materials. The extruder must be able to melt the material to be printed and heating the bed prevents shrinking when the print cools and warping off the bed.

WARNING: Caution also has to be given to any dangerous gases which might be given off on heating a material such as ABS– don't assume it is safe!!!

- PLA is not known to give off these gases.

2.0 Materials

There are a variety of different materials that this 3D printer can be use due to its range in temperatures.

[2.1 PLA](#)

PLA (polyester called polylactic acid or polylactide) is derived from renewable sources such as corn starch. This makes it biodegradable and recyclable therefore easier to dispose of and with no harmful gases given off when used. The extruder melts the PLA at a temperature of 220°C, by heating the bed to a temperature of 70°C for print of anything of significant size or height can maintain adhesion to the bed. The Dyson Centre currently stocks natural (off white), red, blue, orange, yellow, black and grey at a price of around £25 per kg (for reasonable quality filament). Other colours can be ordered such as white, clear, grey, green, purple. Also (for up to twice the cost) fluorescent colours, gold colour, translucent filament, thermochromatic and photochromatic colours wood colours, filaments with sparkly inclusions.

“PLA is an organic material, often made from corn starch or sugar cane, making it quite safe to use as far as fumes are concerned. Currently there is very limited official information available about the effects of PLA on our health.” Taken from <http://3dprintheq.com/desktop-3d-printer-safety/>

[2.2 ABS](#)

ABS (acrylonitrile butadiene styrene) is made from fossil fuels and therefore will release harmful gasses and like PLA, is recyclable. There are some biodegradable versions now coming on market, but most are not biodegradable. The extruder temperature needs to be at 240°C with the bed temperature at 100°C or higher to create a successful print, the area also need to be ventilated due to the gasses released. Suppliers stock a range of colours however, due to the problem of ventilation the Dyson centre does not currently use PLA. ABS is technically stronger than PLA, however doesn't bond to itself as well, resulting in 3D printed parts are about same strength as PLA. ABS is also a little bit more temperature resistance than PLA.

“A few studies have shown ABS fumes to be toxic to rats and mice and there is a fair chance that ABS fumes are more harmful than PLA fumes, mostly due to higher levels of emissions and higher toxicity.” “Recent studies have shown that ABS emits around 10 times as many UFPs (Ultra Fine Particles) as PLA when heated, again making ABS more likely to affect our health than PLA.” Taken from <http://3dprintheq.com/desktop-3d-printer-safety/>

[2.3 Other material available](#)

Many other options are available including:

- Metal laden filaments
- Wood laden filament (sometimes referred to as wood)
- Flexible filaments
- HIPS (High Impact Polystyrene)- dissolvable so might be useful for making a mould which can later be dissolved away.
- PC (polycarbonate)
- PA (polyamide)
- PVA (poly vinyl alcohol)
- Nylon

We have yet to investigate any of the above, in terms of availability (in 1.75mm diameter filament) / cost, Safety of fumes and how well our printers work with them. The printer may be harmed by using them (e.g. acidic compounds given off on heating) so further investigation is needed before using these in every-day use.

[3.0 Where can I get the design?](#)

There are many online databases that offer free downloadable designs that just need to be converted into the right file format.

[3.1 Obtaining an STL File](#)

Websites such as Thingiverse (a universe of things!) and instructables makes this very quick/easy to obtain STL: Standard Triangle/Tessellation Language (or other similar file formats

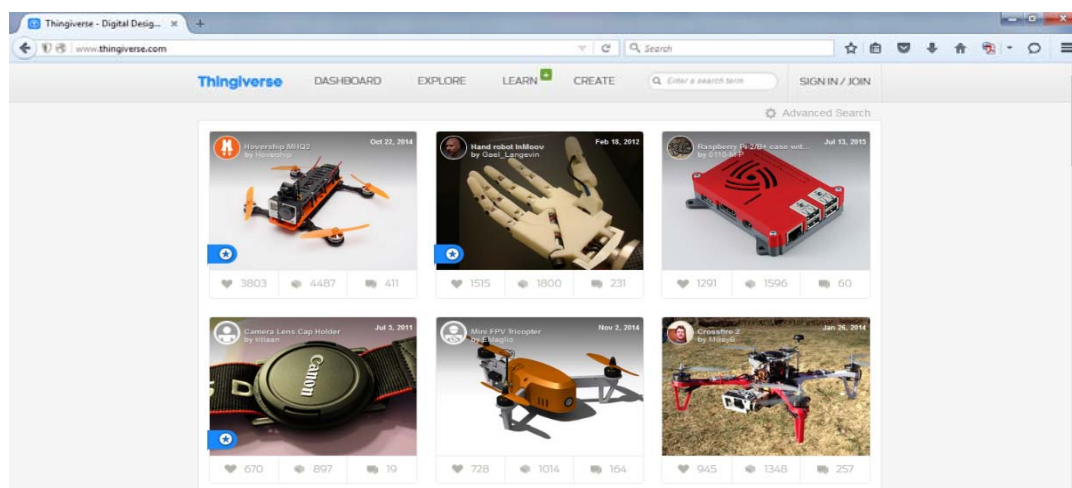

Simply go to the website type in the item or theme that you are interested in downloading, search through of thousands listed designs and download the files needed to create it.

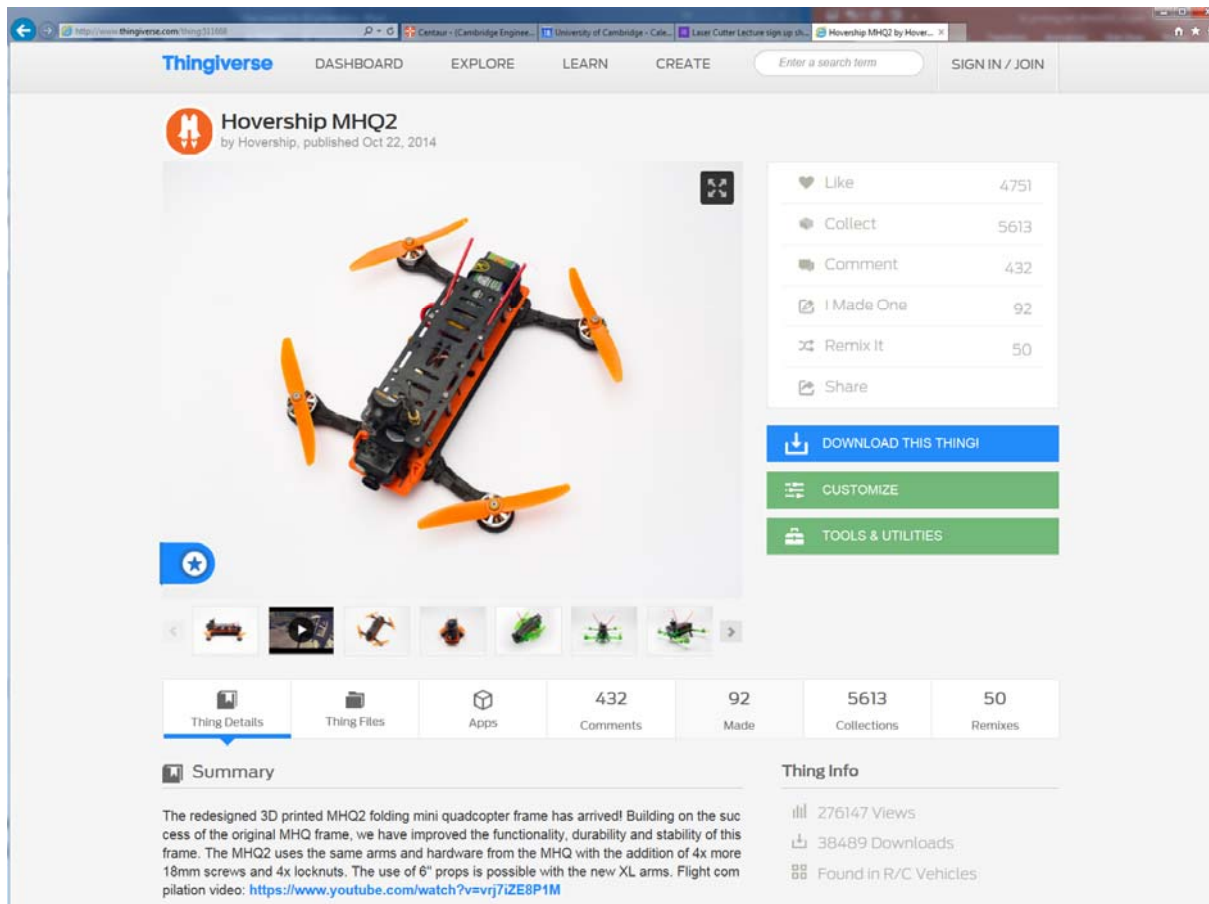

[3.2 Designing a file](#)

The STL file generates very sensitive settings so the user will need to check the STL file provides closed (watertight) surfaces. Still worth checking even in the case of Thingiverse STL files, or if file has been 3D printed before as different printer software processes STL files differently.

If drawing in any of the 3D drawing packages below please see, www.dysoncentre.eng.cam.ac.uk/stl for help outputting STL files.

- [formerly Google's] Sketchup
- Creo (Pro-Engineer)
- Solidworks
- AutoDesk Inventor
- Catia
- IronCAD

- McNeel Rhino
- Solid Edge
- UGS NX

Note that molten plastic has to be supported, so consider adding supports in your model (please see section--- for further details)

3.3 Checking the STL file for errors

A quick check of STL files can be done with a viewer e.g. go to www.viewstl.com and drag/drop (or upload) your (<35MB) STL file.

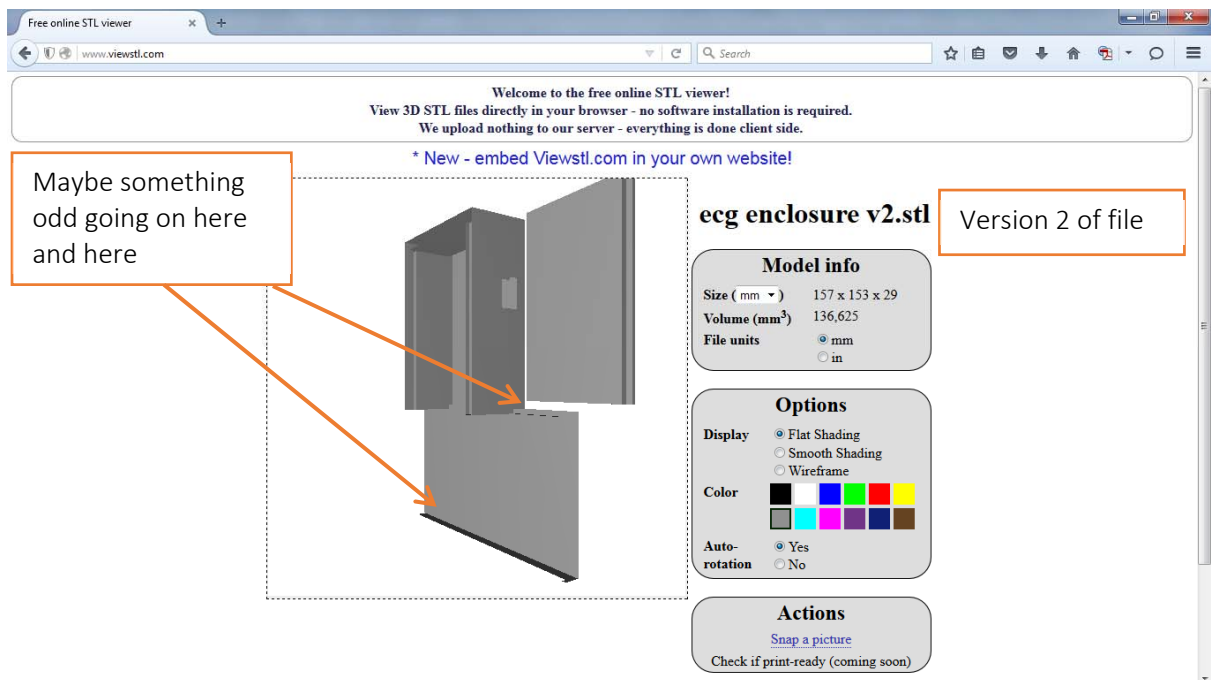
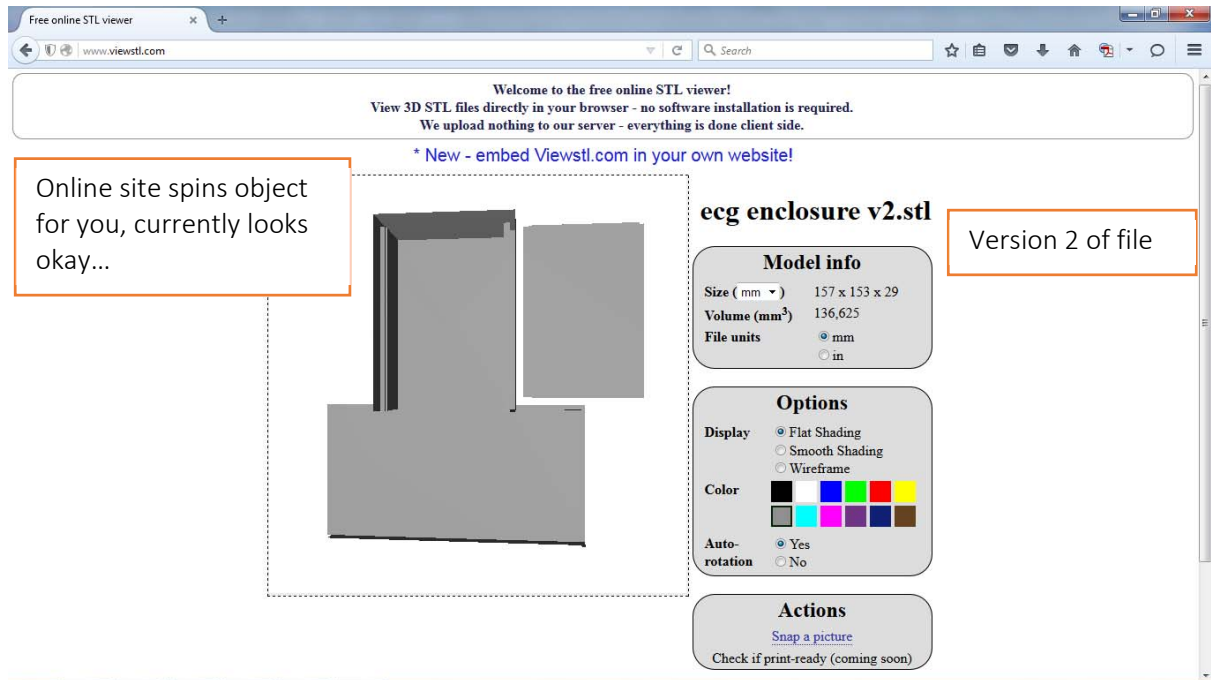

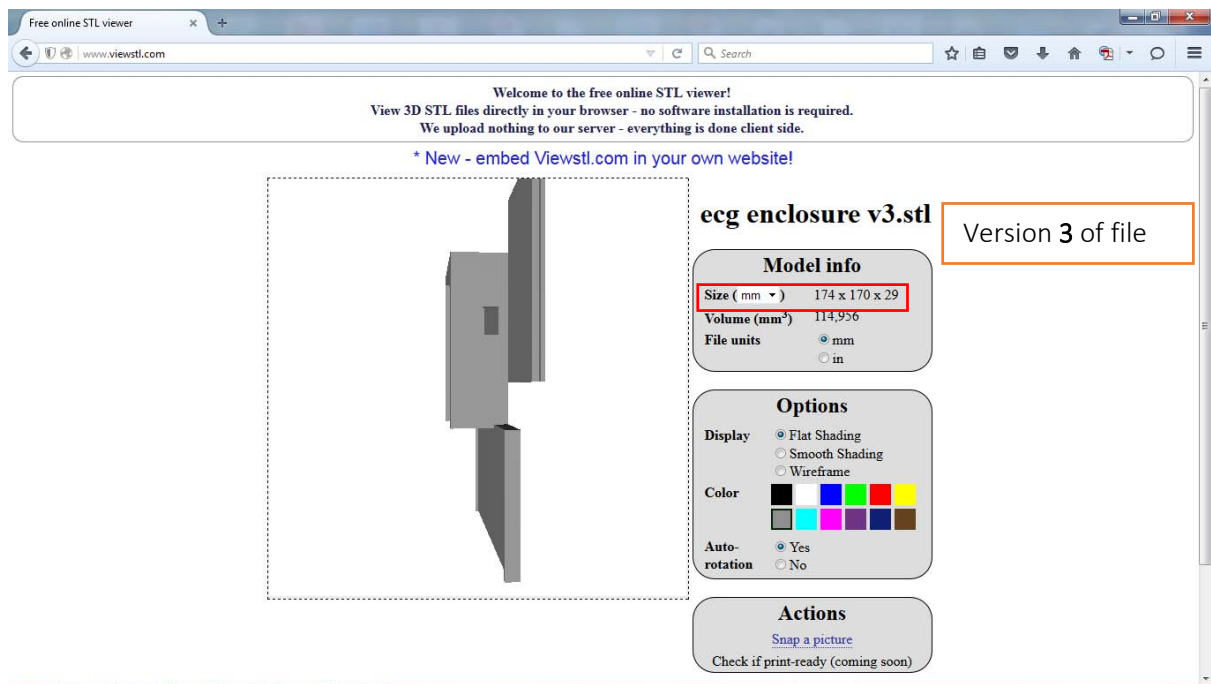
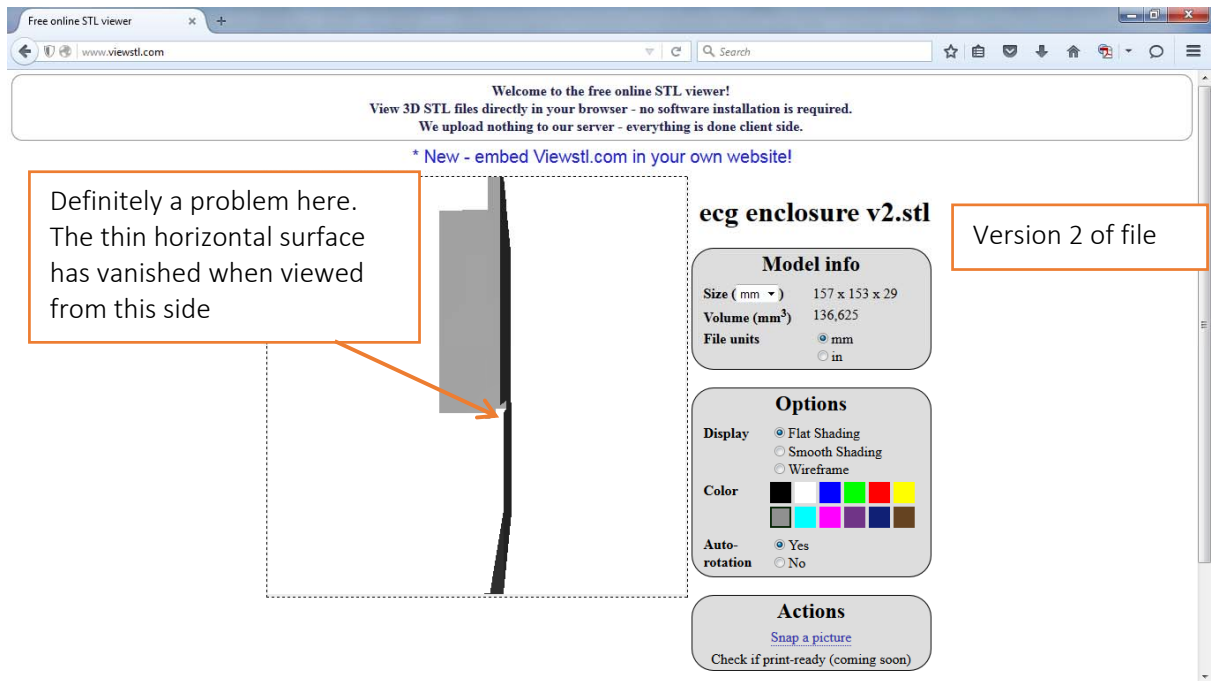

This user then re-exported their STL file using different settings, and the problem seems fixed in this view.

NOTE: it takes seconds to check in this way. The file won't print properly with 'issues' so tends to waste a few hours of printing time.

WARNING: Also important to keep an eye on the size of your model, the IdeaWerk machine can print at most 150mm x 150mm x 140mm high. Note that you can print long thin parts diagonally.

In this case, we could scale down the size of the part (see later on using DoraWare-P).

Also note that excessive scaling down can reduce part thicknesses beyond what is practically printable/durable.

3.3.1 Fixing the STL file errors

Once the errors have been found in the STL file web sites such as the one below can be used to fix these errors.

<https://netfabb.azurewebsites.net/>

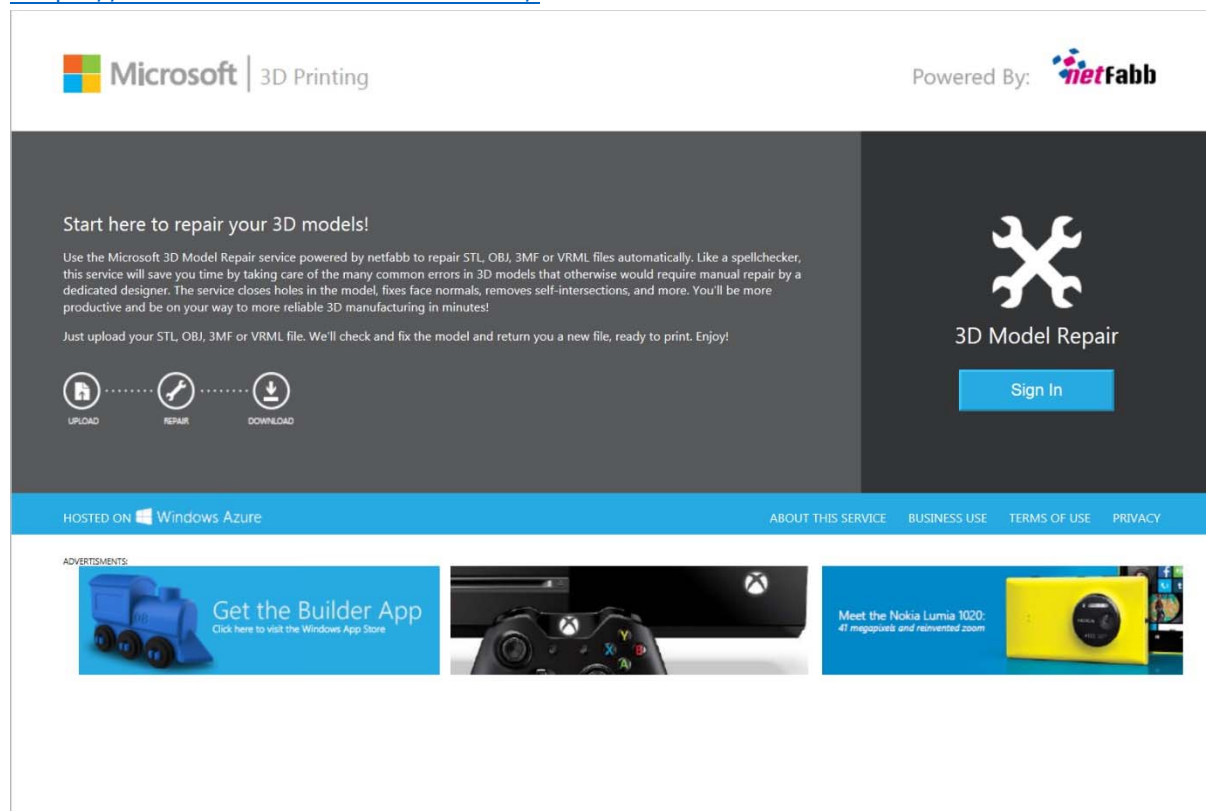

Sign in using I windows account (if you don't have an account you can create one here too) upload your STL file and click 'Repair' the site will go through your file and fix the errors, then you can down load the file. It is recommended that the file be viewed again in the STL checker. If errors still remain the file will need to be corrected in the program originally created in.

[3.4 Processing the STL file using DoraWare-P](#)

To process the STL file into a WTK file which can be fed into the IdeaWerk machine, we use a package called DoraWare-P . You can install this on your own PC at your own risk from: www.dysoncentre.eng.cam.ac.uk/DoraWare or it is installed on the machine/s indicated near the 3D printers. The software takes the arrangement of triangles in 3D space, which represent your surface/s and turns them into instructions for making 2D layers. Instructions for such machines (including CNC milling machines) is known as G-code, which is instructions such as move X by so many millimetres, or move in an arc in the XY plane, centred on this point, etc. DoraWare-P modifies the G-code slightly into a WTK file format. Other 3D printers have other file formats (such as makerbot, etc).

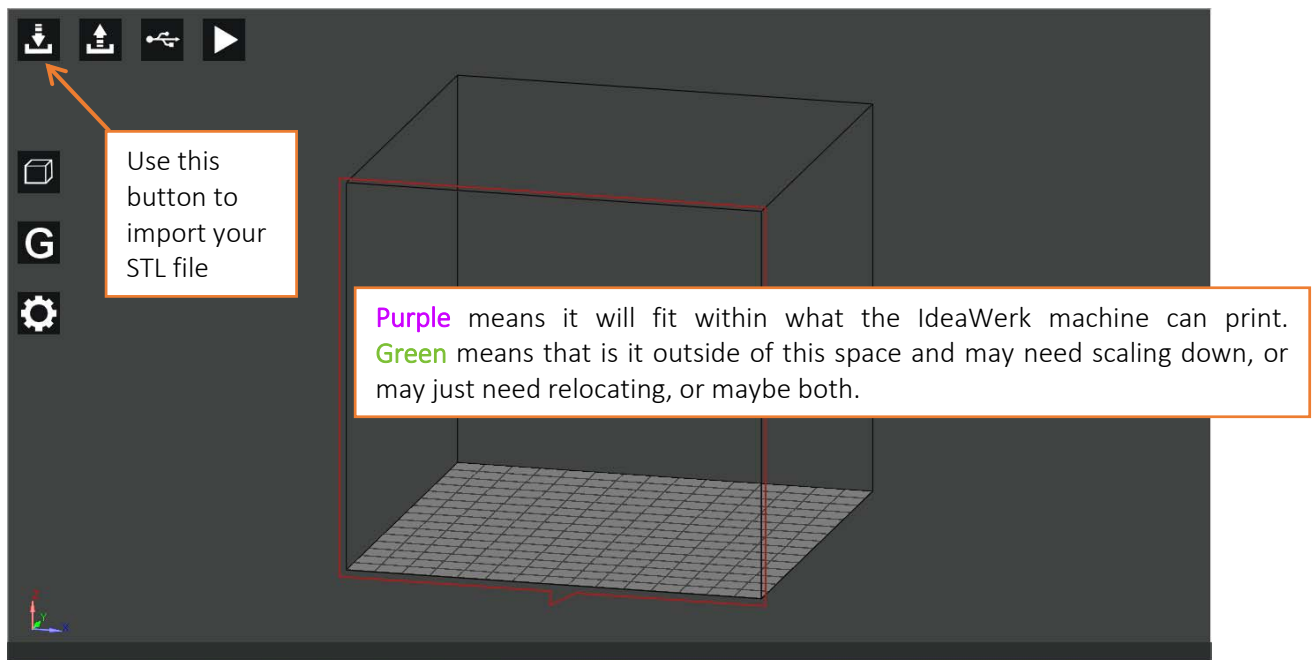

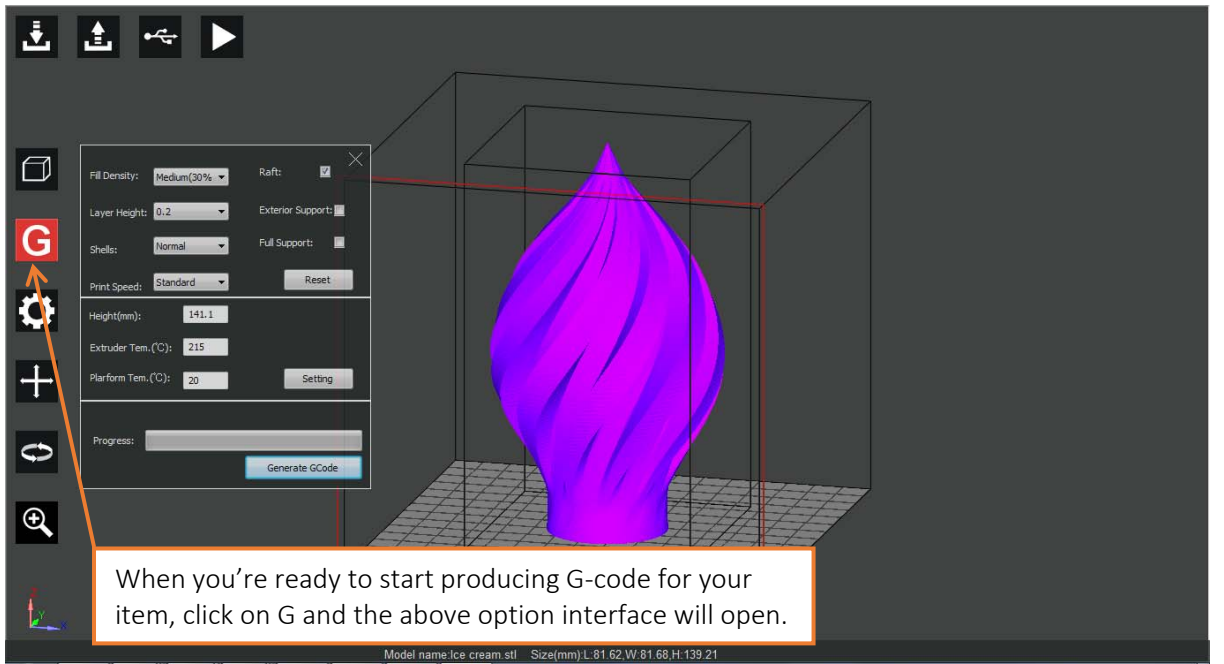
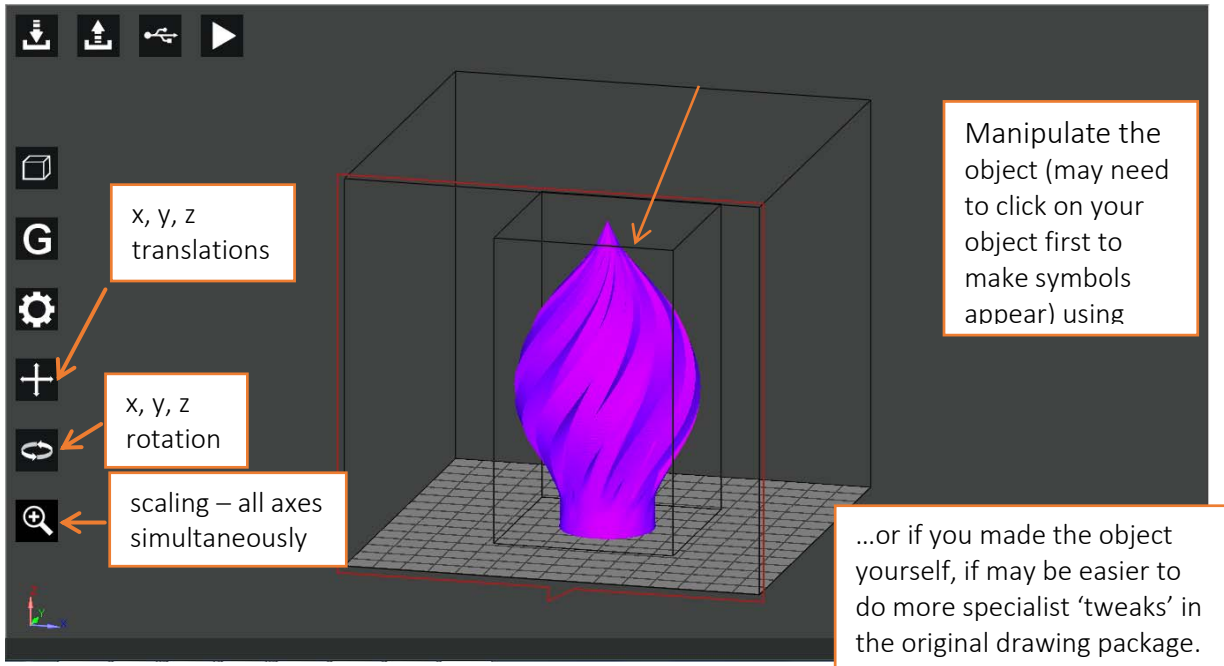

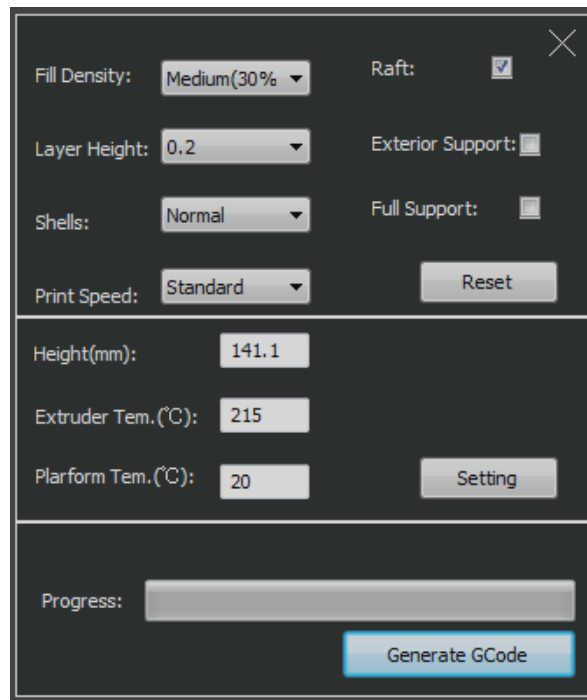

Fill density

3D printed objects are rarely solid usually they consist of a honeycomb centre and a solid shell the drop down for fill density allows you to vary the amount of material in the honeycomb.

Layer Height and Print speed

How thick a layer (in mm) the printer tries to lay down at once, and how fast it is traversing will have an effect in print quality. 0.2mm and standard print speed seem to produce good results, as do faster and thicker settings for crude items.

Shell

Enables you to vary the thickness of the solid shell. What to pick will vary a little depending on what you want the part for, but the default setting for both is not a bad start point.

Raft

Raft produces a layer under your item, which helps it to stay stuck to the print bed, whilst the item is being printed. It will easily peel away from your item, and we do not recommend you untick this option. The raft also helps to compensate for any misalignment and/or irregularity in the bed.

Exterior Supports

This refers to temporary (break away) vertical columns which the printer prints under your item, to help the printer print runs of material which would otherwise constitute it trying to lay down molten plastic in mid-air, which wouldn't work. Our two options are:

- Exterior support (i.e. underneath it, between it and the bed/raft). **OR**
- Full support (where all overhangs further up are also supported).

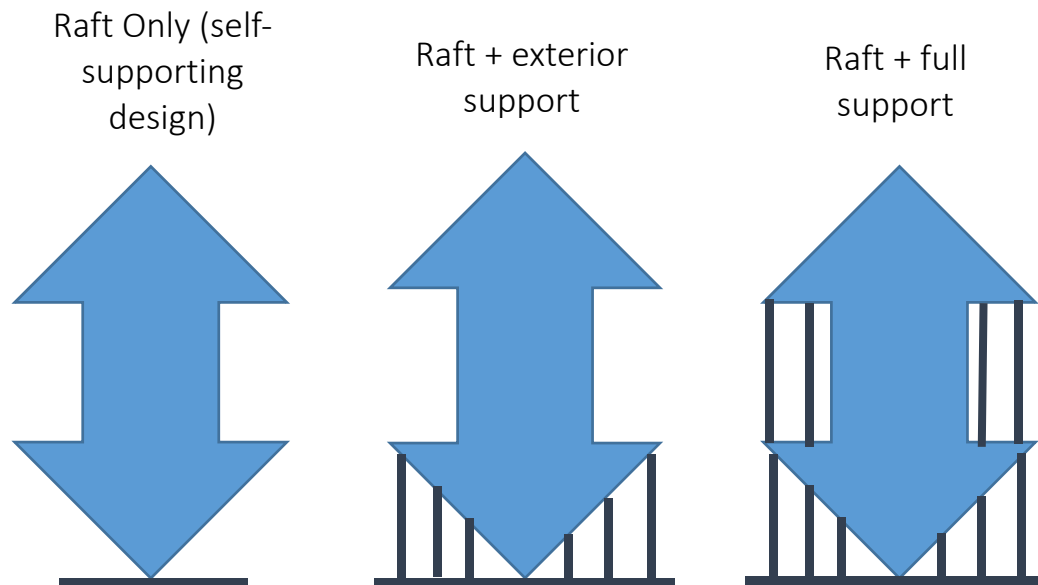

Height(mm)

Setting the [maximum?] height of the model doesn't seem to have much point, unless you have a modified machine.

Extruder temperature (°C)

For PLA printing set the extruder temperature to 220°C.

Platform temperature (°C)

For PLA printing, set the platform temperature to 70°C if your item is more than about 4cm in diameter, otherwise you could leave it at 20°C. By raising the temperature this avoids shrinkage causing larger items to warp off the bed during printing.

NOTE: These temperature settings will also be entered into the machine to avoid an issue with the way in which it operates.

[3.4.1 Generating the GCode](#)

Click to generate the G-code, the progress bar will then start to show a green bar as it processes each lay of the design. Note that this is computationally fairly complex and that time taken may vary from a few minutes for something simple to about half an hour for the example item with no support to a few hours for a very complex piece. The rate that the progress bar moves is a useful indicator something is happening and how long it could take to complete. Multiple STL files of different designs can be uploaded (space on the bed proving) in DoraWare-P and can then these can produce a single G-code, however it can take a long time to produce the code, so we suggest you combine STL files together outside DoraWare-P, or produce a single STL from your drawing package.

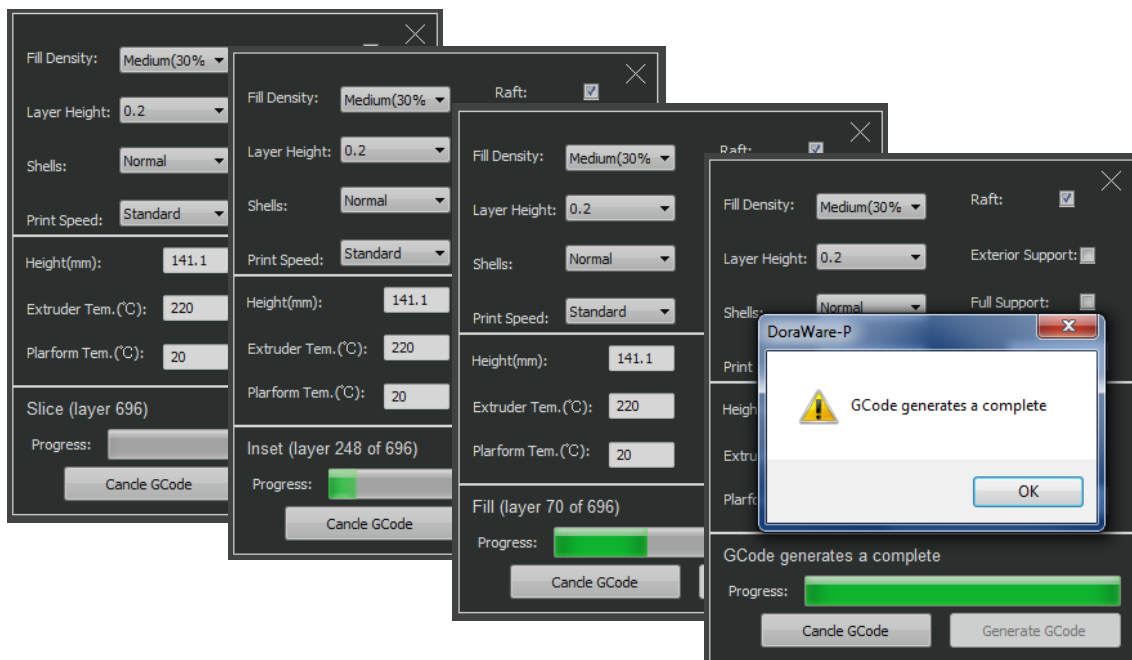

and when we get the message above, we know the G-code has been finished.

[Tracking the problem with the G-code](#)

Sometime when producing the G-code through DoraWare, the print does not turn out the way you expect i.e. holes in gears are filled in. You can check that the problem is not with the G-code via GCODE ANALYZER, go to <http://gcode.ws/>

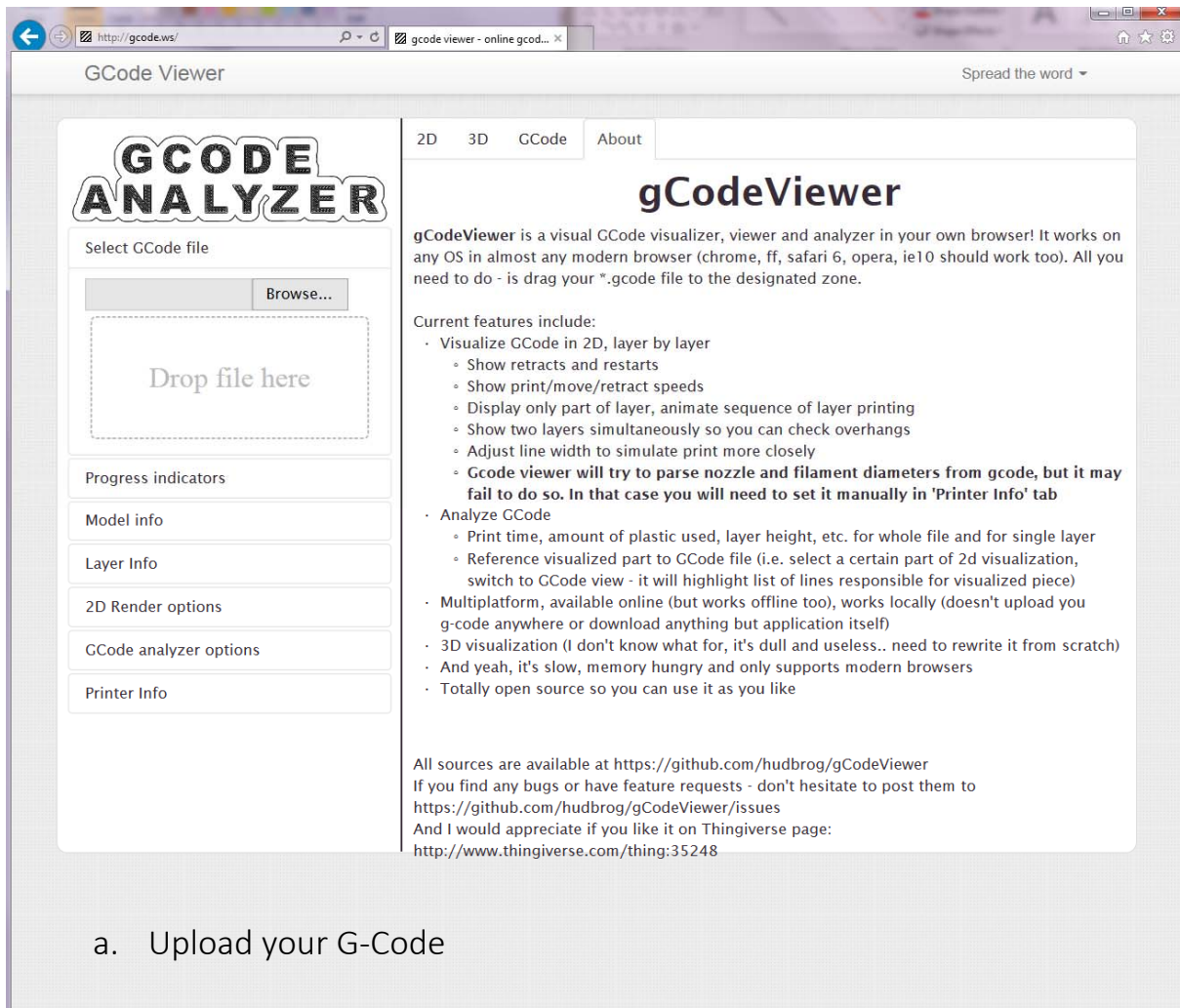

a. Upload your G-Code

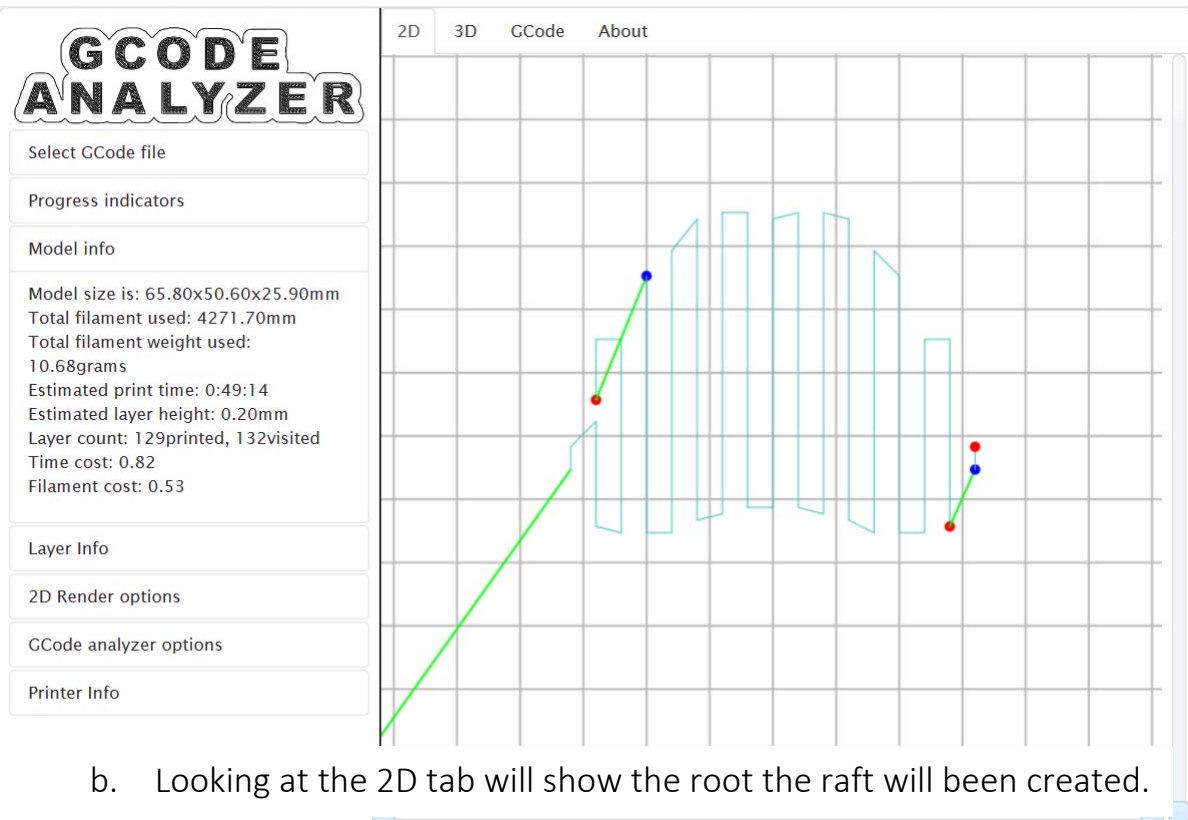

b. Looking at the 2D tab will show the root the raft will be created.

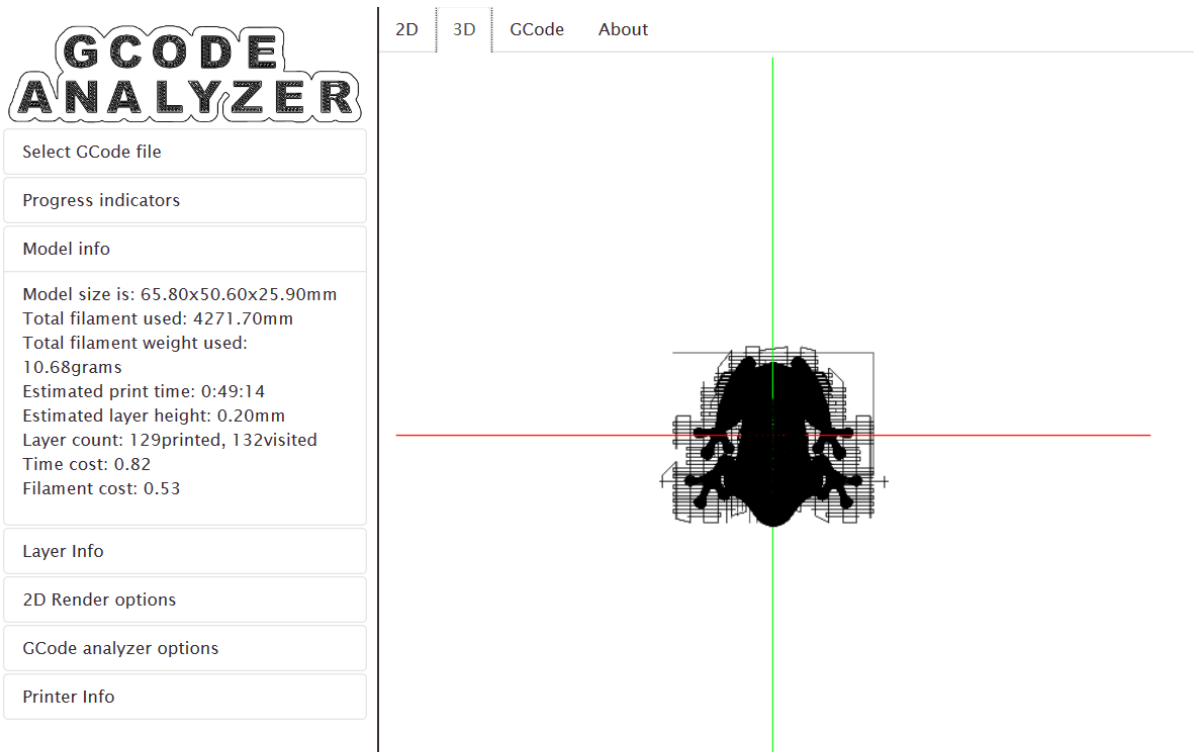

c. Looking at the 3D tab will show the model being created.

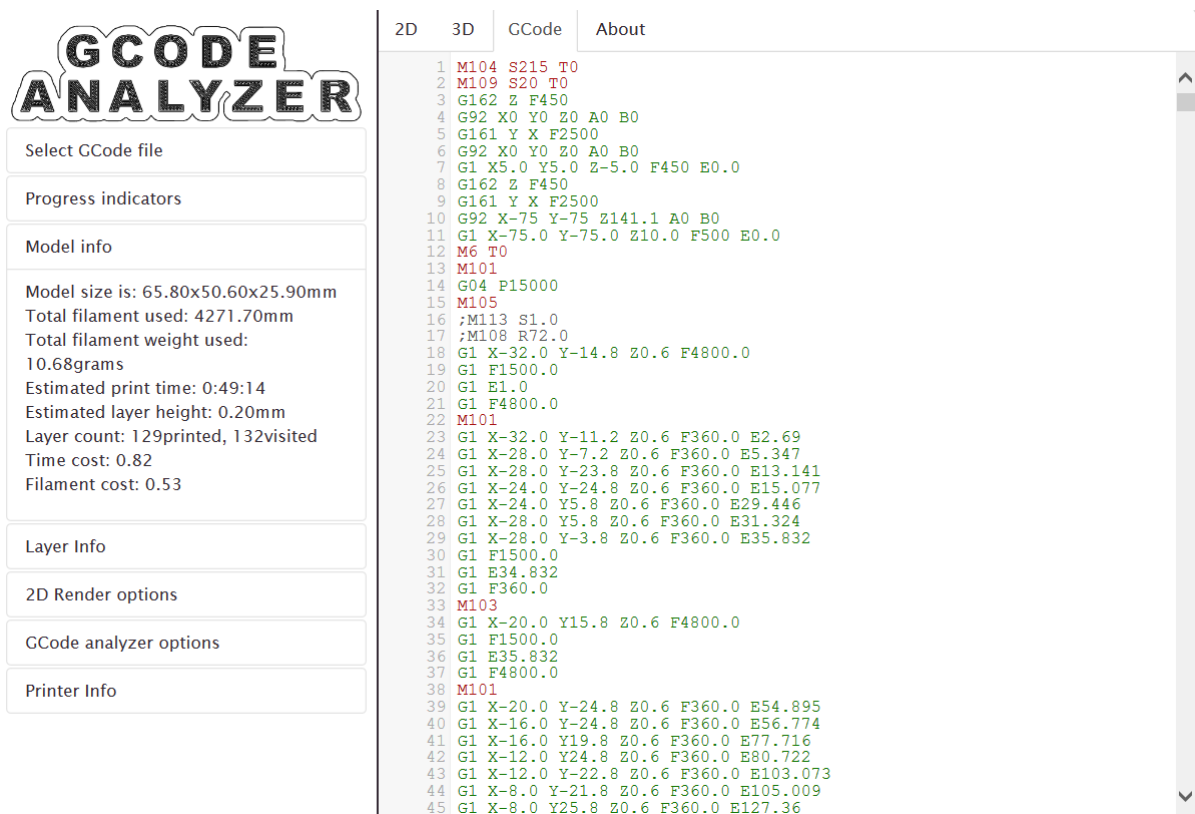

d. Looking at the GCode tab will show the code of the model being created.

Other information included is **Progress indicator**, **Model info**, **Layer Info**, **2D Rendering options**, **GCode analyser options** and **Printer Info**.

GCODE ANALYZER

Select GCode file

Progress indicators

100%

55%

Model info

Model size is: 65.80x50.60x25.90mm
 Total filament used: 4271.70mm
 Total filament weight used: 10.68grams
 Estimated print time: 0:49:14
 Estimated layer height: 0.20mm
 Layer count: 129printed, 132visited
 Time cost: 0.82
 Filament cost: 0.53

Layer Info

Layer number: 0
 Layer height (mm): 0.6
 GCODE commands in layer: 54
 Filament used by layer (mm): 324.28
 Print time for layer: 122.9sec
 Extrude speeds:
 ■ = 25.00mm/s
 ■ = 6.00mm/s
 Move speeds:
 ■ = 80.00mm/s
 ■ = 25.00mm/s
 ■ = 6.00mm/s
 Retract speeds:
 ● = 25.00mm/s

2D Render options

Speed display type:

mm/sec
 mm extrusion per mm move
 mm³/sec

Show non-extrusion moves
 Show retracts and restarts
 Move model to the center of the grid
 Show different speeds with different colors

Emulate extrusion width
 Render lines slightly transparent
 Show +1 layer

Printer Info

Plastic diameter:

Plastic type:
 ABS
 PLA

Nozzle size:

Printer hourly cost:

Filament price(per gram):

GCode analyzer options

These require re-analyzing file:

Sort layers by Z
 Hide empty layers
 Show GCode in GCode tab (memory intensive!)

By looking through these options you are able to see the problem with your design (if any) and check the setting are correct before creating the WTK file to use on the printers. You can then also modify the G-Code file to be create the desired WTK file.

[3.4.2 Producing the WTK file from DoraWare-P](#)

Select the upload icon at the top of the window

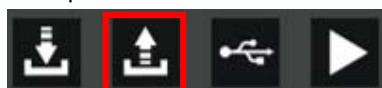

Use this button to export a WTK file to a USB memory stick, select where you would like to save to file, on the Dyson centre USB stick the file needs to be saved under '3DMODEL'.

There are some peculiar requirements and restrictions:

1. Memory stick not larger than 32GB

2. WTK file must be in a directory called 3DMODEL, and this directory must not be within any other directory.
3. The model name of the WTK file before the .WTK must be no more than 8 characters long: e.g.

E:\3DMODEL\Richitem.WTK	fine
E:\3DMODEL\Richardsitem.WTK	won't work

4. The printer can recognise no more than 58 model files on the stick and better to have maximum 20.
5. Not clear of the effect of other content on the stick, and if it might/could corrupt it! (I.e. suggest a dedicated stick.)

4.0 Setting up the RS IdeaWerk Pro 3D printer

Now that the WTK file has been obtained the printer itself now needs to be set up, before using please check:

- The printer is on (at the wall and at at back).
- Also that a black bed is clipped with four clips to the aluminium platform.
- Check that the printer is loaded with the correct filament (both type of plastic and colour) and that there is enough filament to complete the print

4.1 Setting up the printer

When the printer is first powered up the start-up screen will appear as shown below



Touch the screen to access the main menu and other tabs. Now insert your memory stick and select the file you wish to print, touch to select.

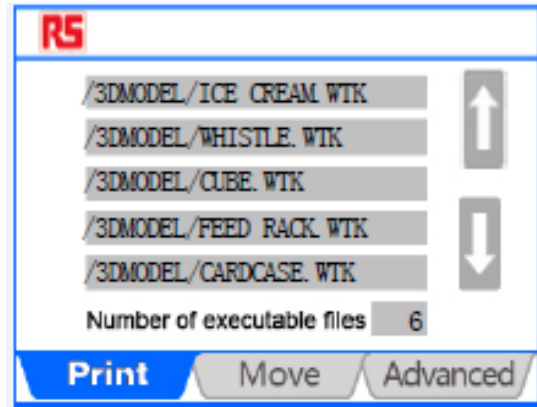
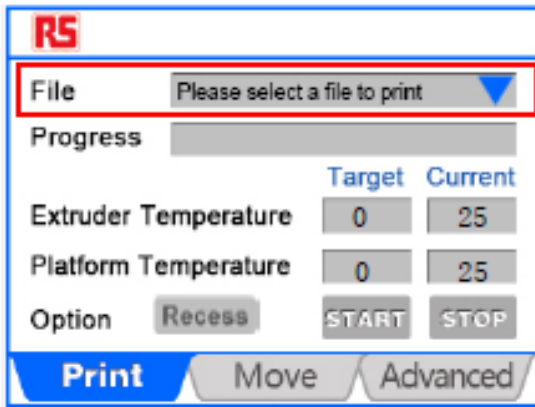

NOTE: Note carefully the format of the screen: Extruder and platform temperatures, and target and current temperatures.

Now select the 'Move' tab and set the extruder and platform temperatures again. To do this tap on the target temperature and type in the number followed by 'ok'. Remember for PLA, extruder 220°C and platform either room temperature or 70°C for anything over about 4cm in diameter.

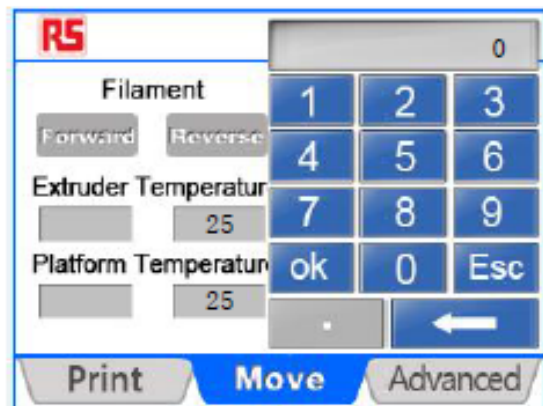
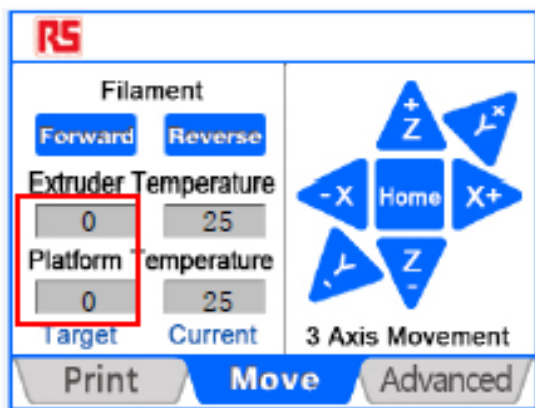

4.2 Starting to print

Now select the 'Print' tab again. Observe for 20 to 30 seconds to check is changing. When you're happy, start the print using the 'Start' button on the 'Print' tab. If it is still heating up it will tell you, and autostart

NOTE: The autostart may happen before the bed has had a chance to heat to the set temperature so if your print is large/tall it may be worth waiting until closer to the set temperature.

NOTE: For the item we considered in DoraWare-P, that would probably take around 8 hours to print.

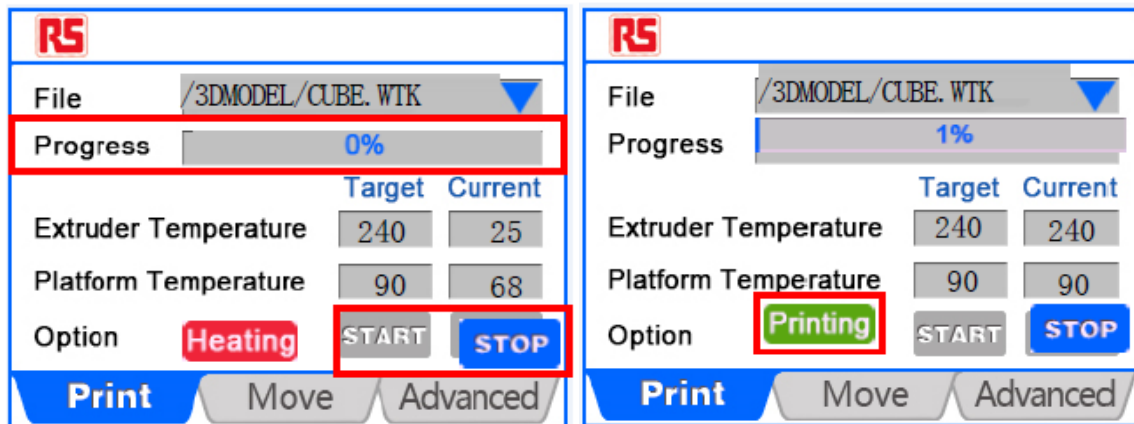

NOTE: When the printer starts to print it will first produces/purge a small amount of filament, this is to get rid of any hard/set filament trapped in or around the extruder.

The print should start to look like the example below.



4.3 Finished printing

Once the print is complete it will drop the bed down to the lowest position and start cooling down, you may want to touch the touch screen (to wake it up) and see what the current temperature of extruder and platform are.

WARNING: The extruder and bed should be cooling down, if not, set them to zero in the 'Move' tab and go back to the 'Print' tab. If they still aren't cooling down, ask for help or switch the printer off at the wall.

NOTE: that throughout the print you can touch the touch-screen to wake it up and see what the percentage progress is.

When you are happy the bed is cool enough (so as not to burn you, but also so that your component isn't still soft and pliable) unclip the four clips and remove the bed. When the printed item is cooled to room temperature, it should be possible to pull it off the bed, or gently flex the bed slightly if need be, taking care not to permanently bend it. Please then replace the bed and clips and don't forget to pay what is owed for the cost of materials.

5.0 Charge forms

We have funds to buy 3D printers for undergraduate use but we do not (yet) have funds to buy materials, so we ask you to pay for these, but the cost is relatively low. We do not have funds to pay for 3D printing for research, except for 4th year projects (or have enough printers for this additional use). If you are a postgraduate/post-doc researcher or a member of staff reading this – please contact the Dyson Centre Manager to discuss further.

5.1 How does it work?

Please use the electronic scales to work out the mass of PLA used, include any scrap, rafts, supports and all failed attempts (these are at your cost). **The charge is £1 per 30g of part there-of**, for example.

25g is £1

40g is £2

60g is £2

61g is £3

For the time being please see the Manager to make payments and ensure you get a receipt. We will try to streamline the payment process in the future.

NOTE: All 3D printing filament payments will go into a dedicated account intended for buying more filament

6.0 Health and Safety

As with many such machines in workshops, these machines are not default safe to use, you can cause harm to yourself and others and to the machine if you don't understand how to use it correctly. An appreciation of the risks and what to do about them is important

6.1 What could go wrong

Could get burnt by extruder or by molten plastic coming out of it – usually between 200 and 280°C (significantly hotter than boiling water).

- Don't touch extruder, or molten plastic coming out of extruder, even if it looks cool.
- Please wear protective gloves provided (to be sufficiently insulated).
- Make sure you know where nearest sink is and get burns under cold water promptly and keep them there for 10 to 20 minutes!

Could get burnt by the platform/bed or item recently printed: if the bed is still being heated, it could be around 100°C

- Don't touch bed until you are sure it has cooled down – touch screen will tell you current temperature (be careful not to get mixed up with target temperature or same for extruder/nozzle).
- Be cautious when moving to handle the bed or the item printed.

Could get trapped above or below the moving [heated] bed and/or the moving [heated] extruder head.

- Keep clear off all moving parts

Harmful gases coming from extruder from heating non-standard materials
Or from overheating standard materials.

- Double check target and actual temperature of extruder.
- Double check what material is being used.
- Ask for advice if printing a non-standard material.
- If you do think you have been exposed to potentially harmful gases, summon a first aider as per three slides ago.

As the extruder is above the auto-ignition temperature of things like paper, there is a chance of the machine easily being able to start a fire.

- Keep the area free from paper, and any other debris.
- If realistically possible, stay with the printer whilst in use, or monitor it using the webcams which will shortly be provided.

- If you do find a fire:
 1. immediately raise the alarm.
 2. if safe to do so, use a fire extinguisher to try to put the fire out, and if possible disconnect the printer from the mains (assuming the electricity cables aren't now damp)
 3. if in doubt, leave the building and raise the alarm.
 4. be careful of breathing in any fumes from the fire.

Also seek help from a first aider – ask at reception if you can't find one, or if outside normal hours, call security on 31818 from the phone on the Manager's desk, or 01223 331818 on your mobile phone. Further details at Manager's desk.

Appendix A -Trouble shooting

Problem: My Print keeps coming away from the bed.

Solution: This could be one of four problems

1. The bed is not heating up
 - Check the temperature setting for the bed
 - Check the current setting to ensure it is heating
2. The extruder head is too far away from the bed
 - Ask a technician to adjust the Z value for the extruder head
3. The design being printed is at an angle that requires additional exterior or full supports to complete the printing.
4. The bed is not level (please report this to a technician to be fixed)

Problem: My design won't print; it heats up but then says that my print is complete

Solution: The WTK file might have been interrupted or did not fully save on to the USB, redo the G-code and resave the file on to USE making sure that the computer tells you that the file has been save successfully.

Problem: I find my file on the USB when I plug it in to print.

Solution: the file name is too long or contains characters that the printer can't identify.

Problem: The printer had left large globules or melted plastic all over my print

Solution: The printer need to be cleaned please report this to the technician.

NOTES